

Description

The 74LVC1G08 is a single 2-input positive AND gate with a standard push-pull output. The device is designed for operation with a power supply range of 1.65V to 5.5V. The inputs are tolerant to 5.5V allowing this device to be used in a mixed voltage environment. The device is fully specified for partial power down applications using I_{OFF}. The I_{OFF} circuitry disables the output preventing damaging current backflow when the device is powered down.

The gate performs the positive Boolean function:

$$Y = A \bullet B \text{ or } Y = \overline{\overline{A} + \overline{B}}$$

Features

- Wide Supply Voltage Range from 1.65 to 5.5V
- ± 24mA Output Drive at 3.3V
- CMOS Low Power Consumption
- I_{OFF} Supports Partial-Power-Down Mode Operation
- Inputs Accept Up to 5.5V
- ESD Protection Tested per JESD 22
 - Exceeds 200-V Machine Model (A115)
 - Exceeds 2000-V Human Body Model (A114)
 - Exceeds 1000-V Charged Device Model (C101)
- Latch-Up Exceeds 100mA per JESD 78, Class I
- Range of Package Options
- Direct Interface with TTL Levels
- **Totally Lead-Free & Fully RoHS Compliant (Notes 1 & 2)**
- **Halogen and Antimony Free. "Green" Device (Note 3)**

Pin Assignments

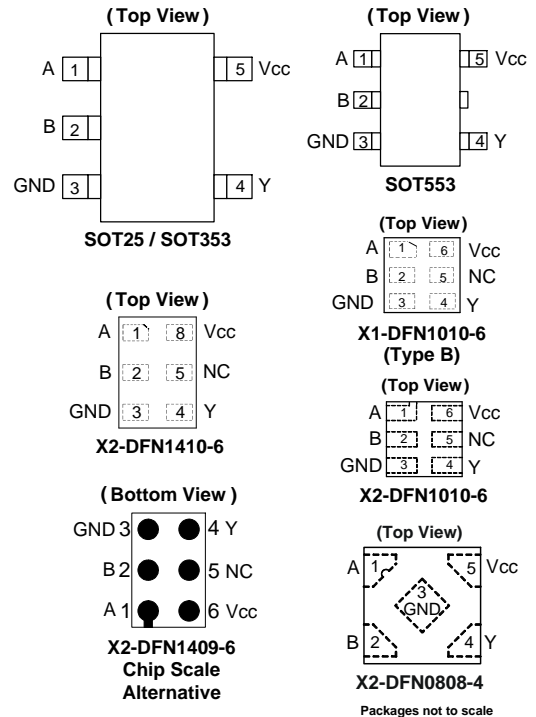

Applications

- Voltage Level Shifting
- General Purpose Logic
- Power Down Signal Isolation
- Wide Array of Products Such as.
 - PCs, Networking, Notebooks, Netbooks, PDAs
 - Tablet Computers, E-readers
 - Computer Peripherals, Hard Drives, CD/DVD ROM
 - TV, DVD, DVR, Set Top Box
 - Cell Phones, Personal Navigation / GPS
 - MP3 Players , Cameras, Video Recorders

- Notes:
1. No purposely added lead. Fully EU Directive 2002/95/EC (RoHS) & 2011/65/EU (RoHS 2) compliant.
 2. See http://www.diodes.com/quality/lead_free.html for more information about Diodes Incorporated's definitions of Halogen- and Antimony-free, "Green" and Lead-free.
 3. Halogen- and Antimony-free "Green" products are defined as those which contain <900ppm bromine, <900ppm chlorine (<1500ppm total Br + Cl) and <1000ppm antimony compounds.

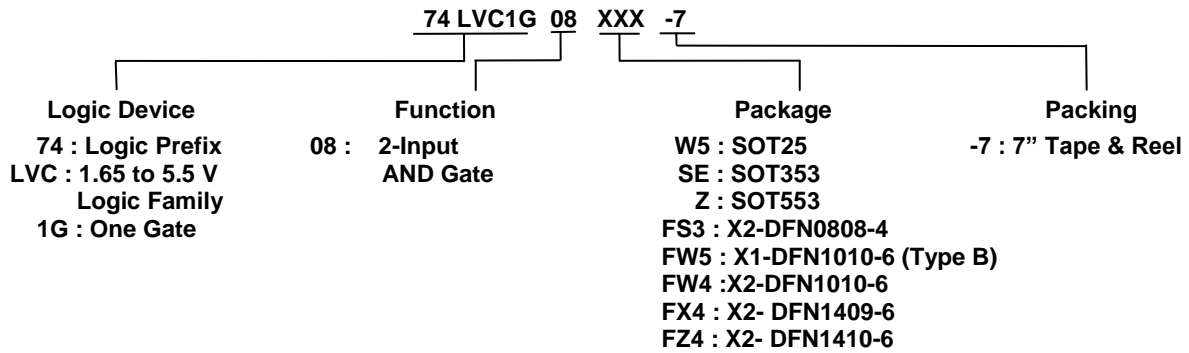
Ordering Information (Note 4)

Part Number	Package Code	Package (Notes 5 & 6)	Package Size	7" Tape and Reel	
				Quantity	Part Number Suffix
74LVC1G08W5-7	W5	SOT25	3.0mm x 2.8mm x 1.2mm 0.95mm lead pitch	3,000/Tape & Reel	-7
74LVC1G08SE-7	SE	SOT353	2.0mm x 2.0mm x 1.1mm 0.65mm lead pitch	3,000/Tape & Reel	-7
74LVC1G08Z-7	Z	SOT553	1.6mm x 1.6 mm x 0.62mm 0.5mm lead pitch	4,000/Tape & Reel	-7
74LVC1G08FS3-7	FS3	X2-DFN0808-4	0.8mm x 0.8mm x 0.35mm 0.5mm pad pitch (diamond)	5,000/Tape & Reel	-7
74LVC1G08FW5-7	FW5	X1-DFN1010-6 (Type B)	1.0mm x 1.0mm x 0.5mm 0.35mm pad pitch	5,000/Tape & Reel	-7
74LVC1G08FW4-7	FW4	X2-DFN1010-6	1.0mm x 1.0mm x 0.4mm 0.35mm pad pitch	5,000/Tape & Reel	-7
74LVC1G08FX4-7	FX4	X2-DFN1409-6 (Chip scale alternative)	1.4mm x 0.9mm x 0.4mm 0.5mm pad pitch	5,000/Tape & Reel	-7
74LVC1G08FZ4-7	FZ4	X2-DFN1410-6	1.4mm x 1.0mm x 0.4mm 0.5mm pad pitch	5,000/Tape & Reel	-7

- Notes:
4. For packaging details, go to our website at <http://www.diodes.com/products/packages.html>.
 5. Pad layout as shown on Diodes Inc. suggested pad layout which can be found on our website at <http://www.diodes.com/package-outlines.html>.
 6. The taping orientation is located on our website at <http://www.diodes.com/datasheets/ap02007.pdf>.

Pin Descriptions

Pin Name	Description
A	Data Input
B	Data Input
GND	Ground
Y	Data Output
V _{CC}	Supply Voltage
NC	No Connection

Logic Diagram

Function Table

Inputs		Output
A	B	Y
H	H	H
L	X	L
X	L	L

Absolute Maximum Ratings (Notes 7 & 8) (@T_A = +25°C, unless otherwise specified.)

Symbol	Description	Rating	Unit
ESD HBM	Human Body Model ESD Protection	2	kV
ESD CDM	Charged Device Model ESD Protection	1	kV
ESD MM	Machine Model ESD Protection	200	V
V _{CC}	Supply Voltage Range	-0.5 to 6.5	V
V _I	Input Voltage Range	-0.5 to 6.5	V
V _O	Voltage Applied to Output in High Impedance or I _{OFF} State	-0.5 to 6.5	V
V _O	Voltage Applied to Output in High or Low State.	-0.5 to V _{CC} +0.5	V
I _{IK}	Input Clamp Current V _I < 0	-50	mA
I _{OK}	Output Clamp Current	-50	mA
I _O	Continuous Output Current	±50	mA
I _{CC} , I _{GN}	Continuous Current Through V _{CC} or GND	±100	mA
T _J	Operating Junction Temperature	-40 to +150	°C
T _{STG}	Storage Temperature	-65 to +150	°C

- Notes:
- Stresses beyond the absolute maximum may result in immediate failure or reduced reliability. These are stress values and device operation should be within recommend values.
 - Forcing the maximum allowed voltage could cause a condition exceeding the maximum current or conversely forcing the maximum current could cause a condition exceeding the maximum voltage. The ratings of both current and voltage must be maintained within the controlled range..

Recommended Operating Conditions (Note 9) (@T_A = +25°C, unless otherwise specified.)

Symbol	Parameter	Min	Max	Unit	
V _{CC}	Operating Voltage	Operating	1.65	5.5	V
		Data Retention Only	1.5	—	V
V _{IH}	High-Level Input Voltage	V _{CC} = 1.65V to 1.95V	0.65 x V _{CC}	—	V
		V _{CC} = 2.3V to 2.7	1.7	—	
		V _{CC} = 3 V to 3.6V	2	—	
		V _{CC} = 4.5V to 5.5V	0.7 x V _{CC}	—	
V _{IL}	Low-Level Input Voltage	V _{CC} = 1.65V to 1.95V	—	0.35 x V _{CC}	V
		V _{CC} = 2.3V to 2.7V	—	0.7	
		V _{CC} = 3V to 3.6V	—	0.8	
		V _{CC} = 4.5V to 5.5V	—	0.3 x V _{CC}	
V _I	Input Voltage	0	5.5	V	
V _O	Output Voltage	0	V _{CC}	V	
I _{OH}	High-Level Output Current	V _{CC} = 1.65V	—	-4	mA
		V _{CC} = 2.3V	—	-8	
		V _{CC} = 2.7V	—	-12	
		V _{CC} = 3V	—	-16	
		V _{CC} = 4.5V	—	-32	
I _{OL}	Low-Level Output Current	V _{CC} = 1.65V	—	4	mA
		V _{CC} = 2.3V	—	8	
		V _{CC} = 2.7V	—	12	
		V _{CC} = 3V	—	16	
		V _{CC} = 4.5V	—	32	
Δt/ΔV	Input Transition Rise or Fall Rate	V _{CC} = 1.8V ± 0.15V, 2.5V ± 0.2V	—	20	ns/V
		V _{CC} = 3.3V ± 0.3V	—	10	
		V _{CC} = 5V ± 0.5V	—	5	
T _A	Operating Free-Air Temperature	—	-40	+125	°C

- Note: 9. Unused inputs should be held at V_{CC} or Ground.

Electrical Characteristics (All typical values are at $V_{CC} = 3.3V$, $T_A = +25^\circ C$)

Symbol	Parameter	Test Conditions	V _{CC}	-40°C to +85°C			-40°C to +125°C		Unit
				Min	Typ.	Max	Min	Max	
V _{OH}	High Level Output Voltage	I _{OH} = -100μA	1.65V to 5.5V	V _{CC} - 0.1	—	—	V _{CC} - 0.1	—	V
		I _{OH} = -4mA	1.65V	1.2	—	—	0.95	—	
		I _{OH} = -8mA	2.3V	1.9	—	—	1.7	—	
		I _{OH} = -12mA	2.7V	2.2	—	—	1.9	—	
		I _{OH} = -16mA	3V	2.4	—	—	2.2	—	
		I _{OH} = -24mA		2.3	—	—	2.0	—	
		I _{OH} = -32mA	4.5V	3.8	—	—	3.4	—	
V _{OL}	Low Level Output Voltage	I _{OL} = 100μA	1.65V to 5.5V	—	—	0.1	—	0.1	V
		I _{OL} = 4mA	1.65V	—	—	0.45	—	0.7	
		I _{OL} = 8mA	2.3V	—	—	0.3	—	0.45	
		I _{OL} = 12mA	2.7V	—	—	0.4	—	0.6	
		I _{OL} = 16mA	3V	—	—	0.4	—	0.6	
		I _{OL} = 24mA		—	—	0.55	—	0.8	
		I _{OL} = 32mA	4.5V	—	—	0.55	—	.8	
I _I	Input Current	V _I = 5.5V or GND	0 to 5.5V	—	± 0.1	±5	—	± 100	μA
I _{OFF}	Power Down Leakage Current	V _I or V _O = 5.5V	0V	—	—	±10	—	±200	μA
I _{CC}	Supply Current	V _I = 5.5V or GND, I _O = 0	5.5V	—	0.1	10	—	200	μA
ΔI _{CC}	Additional Supply Current	One input at V _{CC} -0.6V Other inputs at V _{CC} or GND	3V to 5.5V	—	—	500	—	5,000	μA
C _i	Input Capacitance	V _i = V _{CC} — or GND	3.3V	—	5	—	—	—	pF

Package Characteristics (All typical values are at $V_{CC} = 3.3V$, $T_A = +25^\circ C$)

Symbol	Parameter	Test Conditions	V _{CC}	Min	Typ	Max	Unit
θ _{JA}	Thermal Resistance Junction-to-Ambient	SOT25	(Note 10)	—	204	—	°C/W
		SOT353		—	371	—	
		SOT553		—	231	—	
		X2-DFN0808-4		—	400	—	
		X1-DFN1010-6 (Type B)		—	435	—	
		X2-DFN1010-6		—	445	—	
		X2-DFN1409-6		—	470	—	
		X2-DFN1410-6		—	460	—	
θ _{JC}	Thermal Resistance Junction-to-Case	SOT25	(Note 10)	—	52	—	°C/W
		SOT353		—	143	—	
		SOT553		—	105	—	
		X2-DFN0808-4		—	225	—	
		X1-DFN1010-6 (Type B)		—	250	—	
		X2-DFN1010-6		—	250	—	
		X2-DFN1409-6		—	275	—	
		X2-DFN1410-6		—	265	—	

Note: 10. Test condition for each of the 8 package types: Device mounted on FR-4 substrate PC board, 2oz copper, with minimum recommended pad layout.

Switching Characteristics

Figure 1 Typical Values at $T_A = +25^\circ\text{C}$ and nominal voltages 1.8V, 2.5V, 2.7V, 3.3V, and 5.0V.

Parameter	From Input	To Output	V_{CC}	$T_A = -40^\circ\text{C to } +85^\circ\text{C}$			$T_A = -40^\circ\text{C to } +125^\circ\text{C}$		Unit
				Min	Typ.	Max	Min	Max	
t_{pd}	A or B	Y	$1.8\text{V} \pm 0.15\text{V}$	1.0	3.4	8.0	1.0	10.5	ns
			$2.5\text{V} \pm 0.2\text{V}$	0.5	2.2	5.5	0.5	7.0	
			2.7V	0.5	2.5	5.5	0.5	7.0	
			$3.3\text{V} \pm 0.3\text{V}$	0.5	2.1	4.5	0.5	6.0	
			$5.0\text{V} \pm 0.5\text{V}$	0.5	1.7	4.0	0.5	5.5	

Operating Characteristics

$T_A = +25^\circ\text{C}$

Parameter		Test Conditions	$V_{CC} = 1.8\text{V}$	$V_{CC} = 2.5\text{V}$	$V_{CC} = 3.3\text{V}$	$V_{CC} = 5\text{V}$	Unit
			Typ	Typ	Typ	Typ	
C_{pd}	Power Dissipation Capacitance	$f = 10\text{MHz}$	16	16	16	16	pF

Parameter Measurement Information

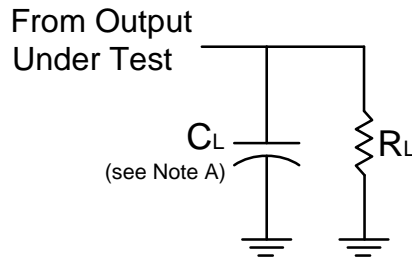

V _{CC}	Inputs		V _M	C _L	R _L
	V _I	t _r /t _f			
1.8V ± 0.15V	V _{CC}	≤2ns	V _{CC} /2	30pF	1KΩ
2.5V ± 0.2V	V _{CC}	≤2ns	V _{CC} /2	30pF	500Ω
2.7V	V _{CC}	≤2.5ns	1.5V	50pF	500Ω
3.3V ± 0.3V	3.0V	≤2.5ns	1.5V	50pF	500Ω
5.0V ± 0.5V	V _{CC}	≤2.5ns	V _{CC} /2	50pF	500Ω

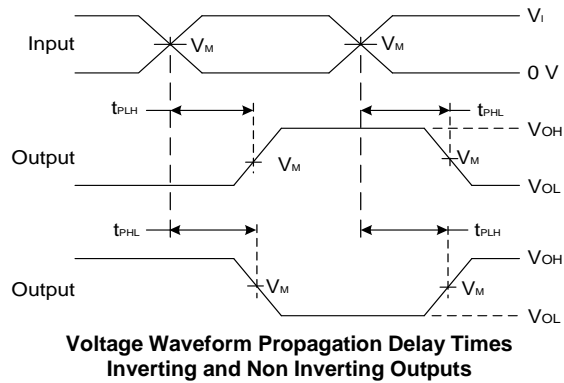
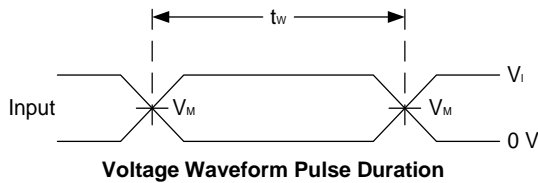
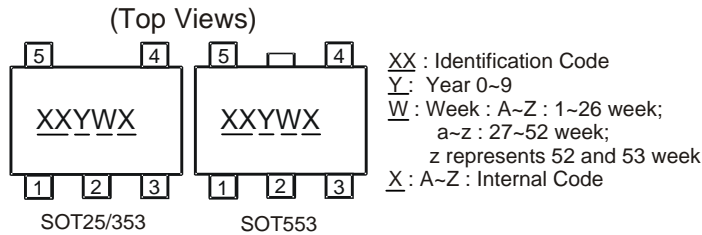

Figure 1 Load Circuit and Voltage Waveforms

- Notes:
- A. Includes test lead and test apparatus capacitance.
 - B. All pulses are supplied at pulse repetition rate ≤ 10MHz.
 - C. Inputs are measured separately one transition per measurement.
 - D. t_{PLH} and t_{PHL} are the same as t_{PD}.

Marking Information

(1) SOT25, SOT353 and SOT553



Part Number	Package	Identification Code
74LVC1G08W5-7	SOT25	UV
74LVC1G08SE-7	SOT353	UV
74LVC1G08Z-7	SOT553	UV

(2) DFN Packages

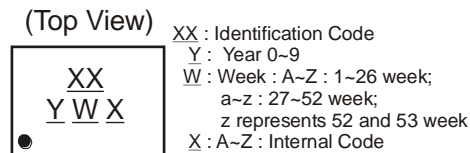

Part Number	Package	Identification Code
74LVC1G08FS3-7	X2-DFN0808-4	WV
74LVC1G08FW5-7	X1-DFN1010-6 (Type B)	V7
74LVC1G08FW4-7	X2-DFN1010-6	UV
74LVC1G08FX4-7	X2-DFN1409-6	MF
74LVC1G08FZ4-7	X2-DFN1410-6	UV

Package Outline Dimensions

Please see <http://www.diodes.com/package-outlines.html> for the latest version.

SOT25

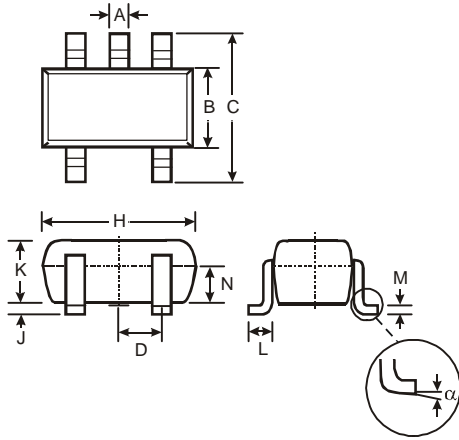

SOT25			
Dim	Min	Max	Typ
A	0.35	0.50	0.38
B	1.50	1.70	1.60
C	2.70	3.00	2.80
D	-	-	0.95
H	2.90	3.10	3.00
J	0.013	0.10	0.05
K	1.00	1.30	1.10
L	0.35	0.55	0.40
M	0.10	0.20	0.15
N	0.70	0.80	0.75
α	0°	8°	-
All Dimensions in mm			

Suggested Pad Layout

Please see <http://www.diodes.com/package-outlines.html> for the latest version.

SOT25

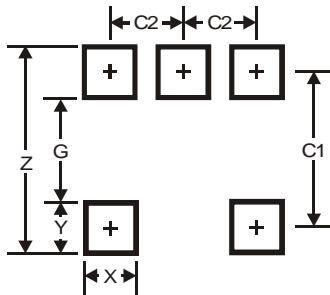

Dimensions	Value
Z	3.20
G	1.60
X	0.55
Y	0.80
C1	2.40
C2	0.95

Package Outline Dimensions

Please see <http://www.diodes.com/package-outlines.html> for the latest version.

SOT353

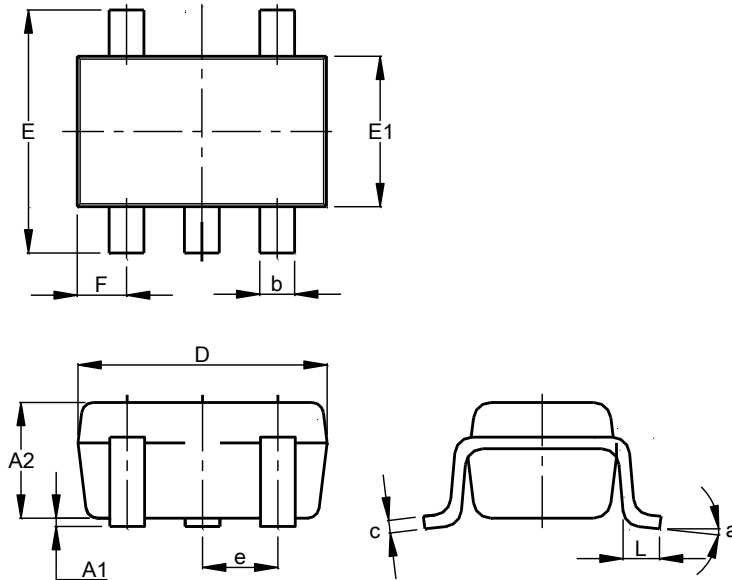

SOT353			
Dim	Min	Max	Typ
A1	0.00	0.10	0.05
A2	0.90	1.00	1.00
b	0.10	0.30	0.25
c	0.10	0.22	0.11
D	1.80	2.20	2.15
E	2.00	2.20	2.10
E1	1.15	1.35	1.30
e	0.650 BSC		
F	0.40	0.45	0.425
L	0.25	0.40	0.30
a	0°	8°	--
All Dimensions in mm			

Suggested Pad Layout

Please see <http://www.diodes.com/package-outlines.html> for the latest version.

SOT353

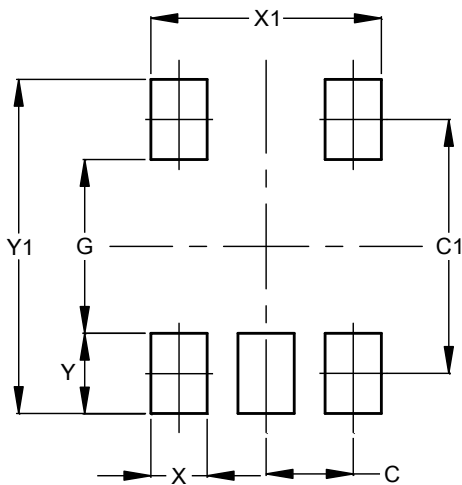

Dimensions	Value (in mm)
C	0.650
C1	1.900
G	1.300
X	0.420
X1	1.720
Y	0.600
Y1	2.500

Package Outline Dimensions

Please see <http://www.diodes.com/package-outlines.html> for the latest version.

SOT553

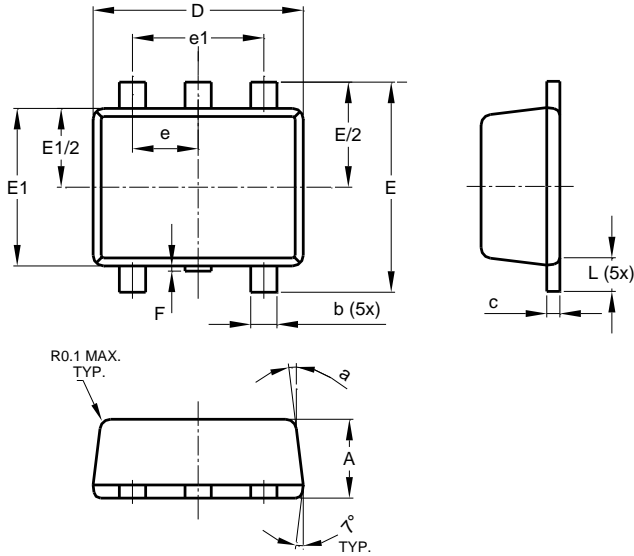

SOT553			
Dim	Min	Max	Typ
A	0.55	0.62	0.60
b	0.15	0.30	0.20
c	0.10	0.18	0.15
D	1.50	1.70	1.60
E	1.55	1.70	1.60
E1	1.10	1.25	1.20
e	0.50 BSC		
e1	1.00 BSC		
F	0.00	0.10	—
L	0.10	0.30	0.20
a	6°	8°	7°
All Dimensions in mm			

Suggested Pad Layout

Please see <http://www.diodes.com/package-outlines.html> for the latest version.

SOT553

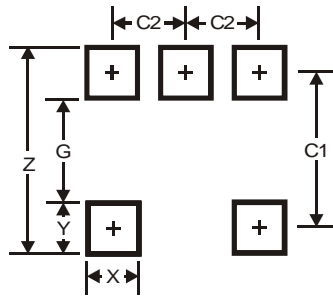

Dimensions	Value
Z	2.2
G	1.2
X	0.375
Y	0.5
C1	1.7
C2	0.5

Package Outline Dimensions

Please see <http://www.diodes.com/package-outlines.html> for the latest version.

X2-DFN0808-4

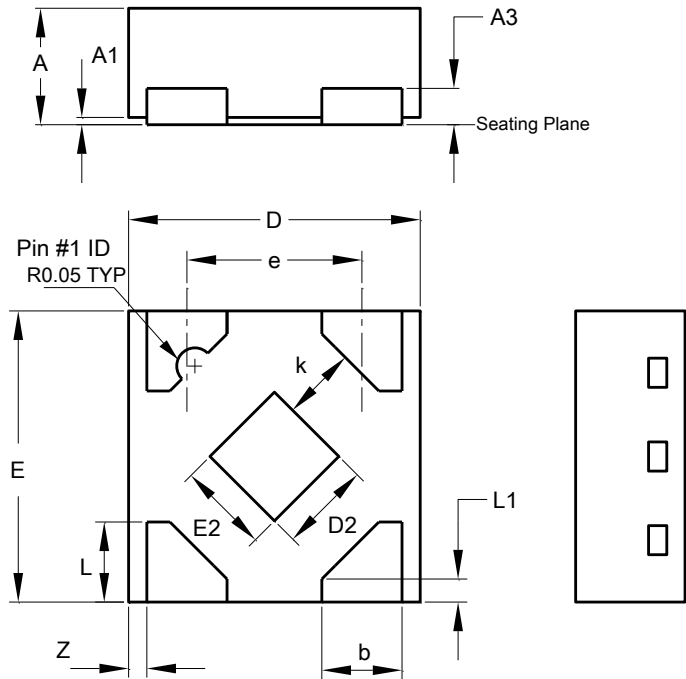

X2-DFN0808-4			
Dim	Min	Max	Typ
A	0.25	0.35	0.30
A1	0	0.04	0.02
A3	-	-	0.13
b	0.17	0.27	0.22
D	0.75	0.85	0.80
D2	0.15	0.35	0.25
E	0.75	0.85	0.80
E2	0.15	0.35	0.25
e	-	-	0.48
k	0.20	-	-
L	0.17	0.27	0.22
L1	0.02	0.12	0.07
z	-	-	0.05

All Dimensions in mm

Suggested Pad Layout

Please see <http://www.diodes.com/package-outlines.html> for the latest version.

X2-DFN0808-4

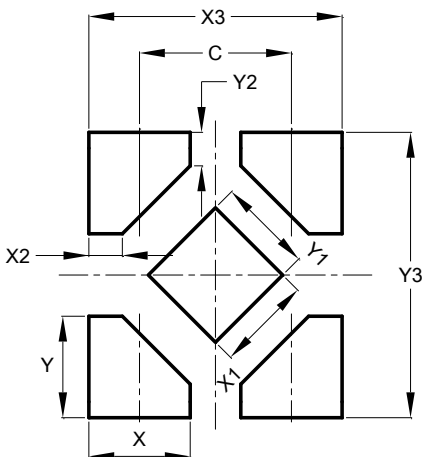

Dimensions	Value
C	0.480
X	0.320
X1	0.300
X2	0.106
X3	0.800
Y	0.320
Y1	0.300
Y2	0.106
Y3	0.900

Package Outline Dimensions

Please see <http://www.diodes.com/package-outlines.html> for the latest version.

X1-DFN1010-6 (Type B)

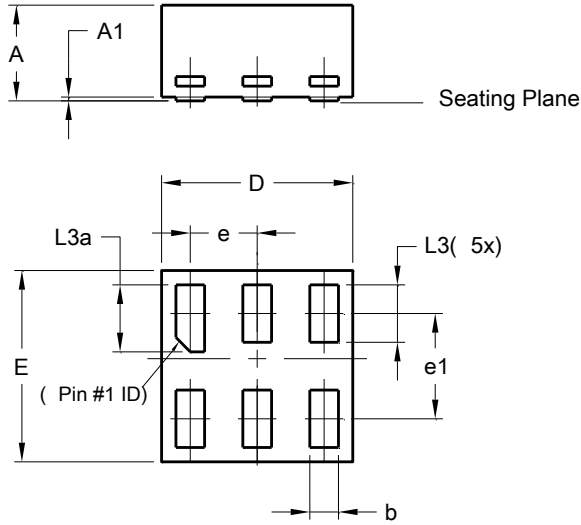

X1-DFN1010-6 (Type B)			
Dim	Min	Max	Typ
A	-	0.50	0.39
A1	-	0.04	-
b	0.12	0.20	0.15
D	0.95	1.050	1.00
E	0.95	1.050	1.00
e	0.35 BSC		
e1	0.55 BSC		
L3	0.27	0.30	0.30
L3a	0.32	0.40	0.35
All Dimensions in mm			

Suggested Pad Layout

Please see <http://www.diodes.com/package-outlines.html> for the latest version.

X1-DFN1010-6 (Type B)

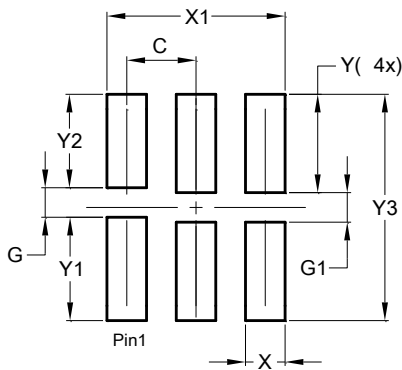

Dimensions	Value (in mm)
C	0.350
G	0.150
G1	0.150
X	0.200
X1	0.900
Y	0.500
Y1	0.525
Y2	0.475
Y3	1.150

Package Outline Dimensions

Please see <http://www.diodes.com/package-outlines.html> for the latest version.

X2-DFN1010-6

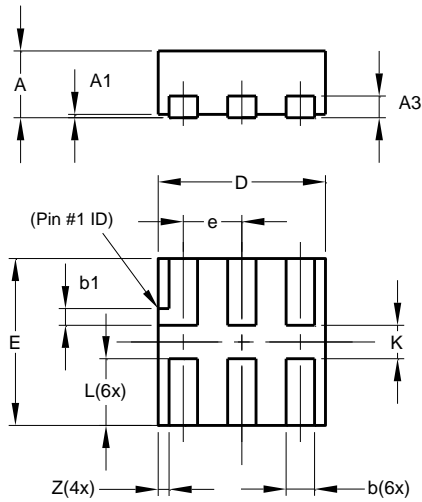

X2-DFN1010-6			
Dim	Min	Max	Typ
A	—	0.40	0.39
A1	0.00	0.05	0.02
A3	—	—	0.13
b	0.14	0.20	0.17
b1	0.05	0.15	0.10
D	0.95	1.05	1.00
E	0.95	1.05	1.00
e	—	—	0.35
L	0.35	0.45	0.40
K	0.15	—	—
Z	—	—	0.065
All Dimensions in mm			

Suggested Pad Layout

Please see <http://www.diodes.com/package-outlines.html> for the latest version.

X2-DFN1010-6

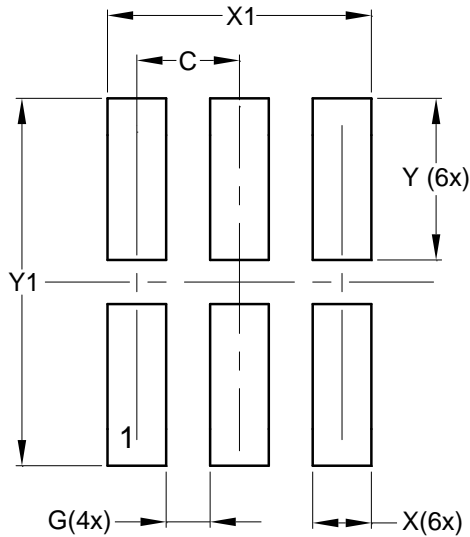

Dimensions	Value (in mm)
C	0.350
G	0.150
X	0.200
X1	0.900
Y	0.550
Y1	1.250

Package Outline Dimensions

Please see <http://www.diodes.com/package-outlines.html> for the latest version.

X2-DFN1409-6 CHIP SCALE ALTERNATIVE

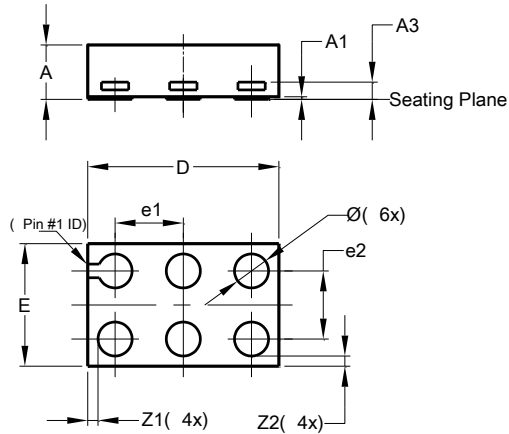

X2-DFN1409-6			
Dim	Min	Max	Typ
A	-	0.40	0.39
A1	0	0.05	0.02
A3	-	-	0.13
Ø	0.20	0.30	0.25
D	1.35	1.45	1.40
E	0.85	0.95	0.90
e1	-	-	0.50
e2	-	-	0.50
Z1	-	-	0.075
Z2	-	-	0.075
All Dimensions in mm			

Suggested Pad Layout

Please see <http://www.diodes.com/package-outlines.html> for the latest version.

X2-DFN1409-6 CHIP SCALE ALTERNATIVE

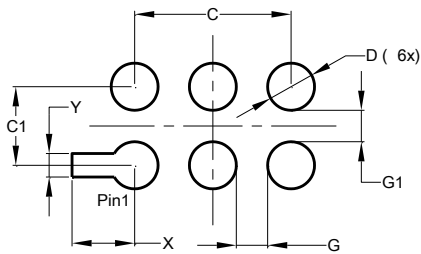

Dimensions	Value (in mm)
C	1.000
C1	0.500
D	0.300
G	0.200
G1	0.200
X	0.400
Y	0.150

Package Outline Dimensions

Please see <http://www.diodes.com/package-outlines.html> for the latest version.

X2-DFN1410-6

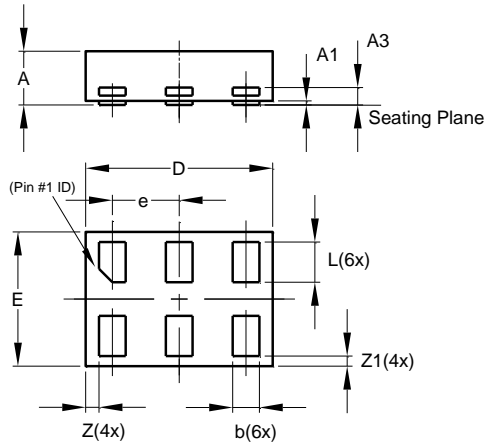

X2-DFN1410-6			
Dim	Min	Max	Typ
A	—	0.40	0.39
A1	0.00	0.05	0.02
A3	—	—	0.13
b	0.15	0.25	0.20
D	1.35	1.45	1.40
E	0.95	1.05	1.00
e	—	—	0.50
L	0.25	0.35	0.30
Z	—	—	0.10
Z1	0.045	0.105	0.075
All Dimensions in mm			

Suggested Pad Layout

Please see <http://www.diodes.com/package-outlines.html> for the latest version.

X2-DFN1410-6

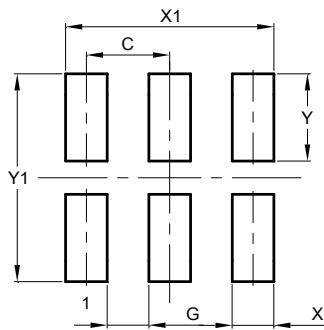

Dimensions	Value (in mm)
C	0.500
G	0.250
X	0.250
X1	1.250
Y	0.525
Y1	1.250

IMPORTANT NOTICE

DIODES INCORPORATED MAKES NO WARRANTY OF ANY KIND, EXPRESS OR IMPLIED, WITH REGARDS TO THIS DOCUMENT, INCLUDING, BUT NOT LIMITED TO, THE IMPLIED WARRANTIES OF MERCHANTABILITY AND FITNESS FOR A PARTICULAR PURPOSE (AND THEIR EQUIVALENTS UNDER THE LAWS OF ANY JURISDICTION).

Diodes Incorporated and its subsidiaries reserve the right to make modifications, enhancements, improvements, corrections or other changes without further notice to this document and any product described herein. Diodes Incorporated does not assume any liability arising out of the application or use of this document or any product described herein; neither does Diodes Incorporated convey any license under its patent or trademark rights, nor the rights of others. Any Customer or user of this document or products described herein in such applications shall assume all risks of such use and will agree to hold Diodes Incorporated and all the companies whose products are represented on Diodes Incorporated website, harmless against all damages.

Diodes Incorporated does not warrant or accept any liability whatsoever in respect of any products purchased through unauthorized sales channel.

Should Customers purchase or use Diodes Incorporated products for any unintended or unauthorized application, Customers shall indemnify and hold Diodes Incorporated and its representatives harmless against all claims, damages, expenses, and attorney fees arising out of, directly or indirectly, any claim of personal injury or death associated with such unintended or unauthorized application.

Products described herein may be covered by one or more United States, international or foreign patents pending. Product names and markings noted herein may also be covered by one or more United States, international or foreign trademarks.

This document is written in English but may be translated into multiple languages for reference. Only the English version of this document is the final and determinative format released by Diodes Incorporated.

LIFE SUPPORT

Diodes Incorporated products are specifically not authorized for use as critical components in life support devices or systems without the express written approval of the Chief Executive Officer of Diodes Incorporated. As used herein:

A. Life support devices or systems are devices or systems which:

1. are intended to implant into the body, or
2. support or sustain life and whose failure to perform when properly used in accordance with instructions for use provided in the labeling can be reasonably expected to result in significant injury to the user.

B. A critical component is any component in a life support device or system whose failure to perform can be reasonably expected to cause the failure of the life support device or to affect its safety or effectiveness.

Customers represent that they have all necessary expertise in the safety and regulatory ramifications of their life support devices or systems, and acknowledge and agree that they are solely responsible for all legal, regulatory and safety-related requirements concerning their products and any use of Diodes Incorporated products in such safety-critical, life support devices or systems, notwithstanding any devices- or systems-related information or support that may be provided by Diodes Incorporated. Further, Customers must fully indemnify Diodes Incorporated and its representatives against any damages arising out of the use of Diodes Incorporated products in such safety-critical, life support devices or systems.

Copyright © 2016, Diodes Incorporated

www.diodes.com